

QUELARC[®] 100 AMP 600 VAC

| |
|-----------------|
| 4 POLE 4 WIRE |
| SOLDER CONTACTS |
| 1 1/2" NPT |

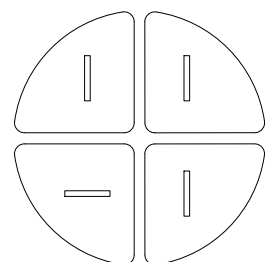
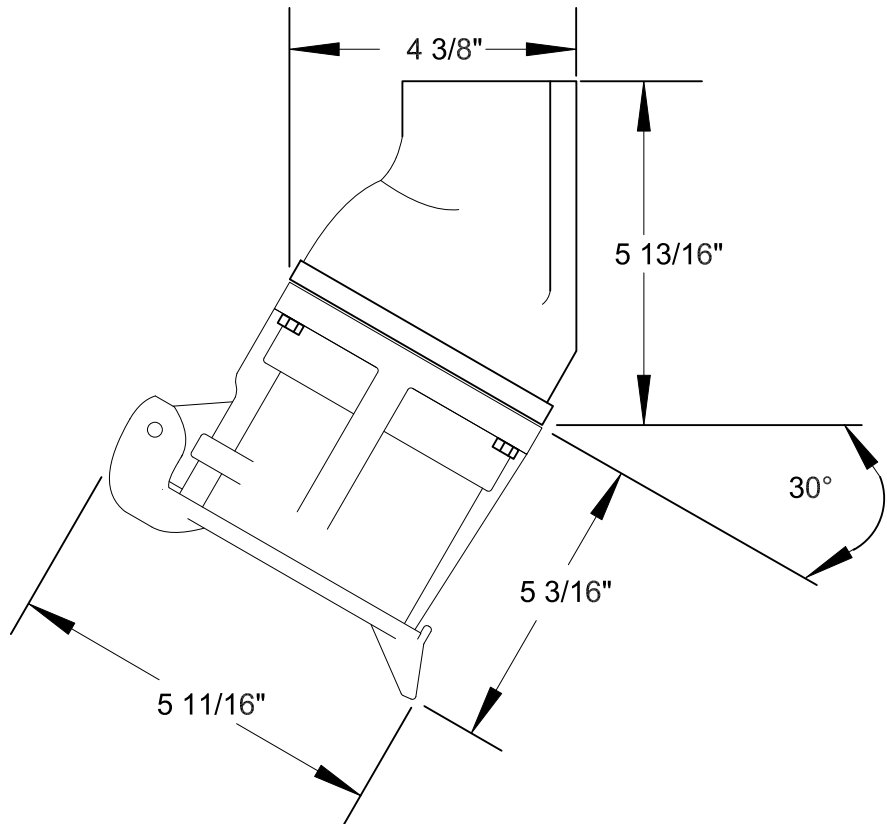
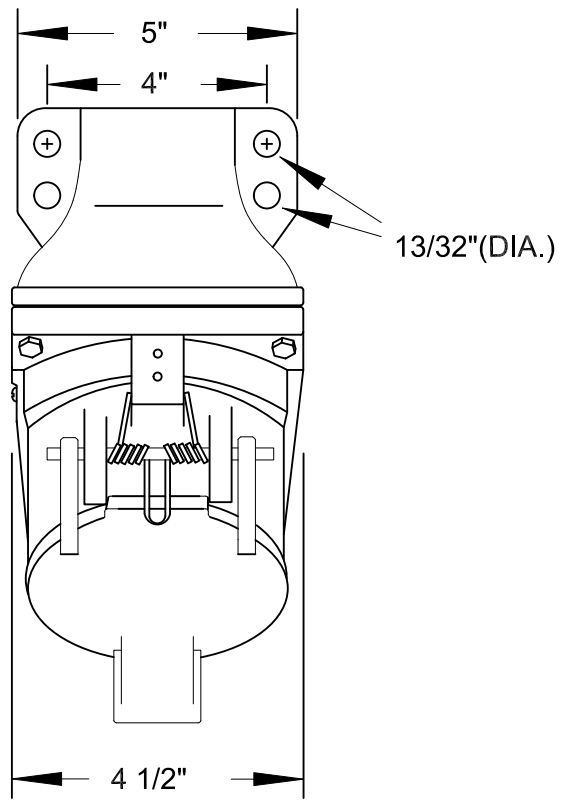

RECEPTACLE FACE

DRAWING NOT TO SCALE

To order contact:
HILLCREST ENTERPRISES, INC.
 11092 AIR PARK ROAD
 ASHLAND, VA 23005 USA

Phone: 804-798-8390
 Fax: 804-752-7830

<http://www.pylenational.co>
<http://www.plugs.cc>

| | | | | |
|-----------------|------|-----------------------|---------|--------|
| DRAWN BY | NVS | HILLCREST ENTERPRISES | | |
| APPROVED | 4/14 | KRCBB-510046 | | |
| ISSUED | | | | |
| RECORD OF ISSUE | | SCALE | DRG No. | SHEET |
| | | | | 1 OF 1 |